

# Service Document **Exchange Set**

## **YACHT BOY 80 WR5408 PLL**

|                                      |
|--------------------------------------|
| <b>Service Manual</b>                |
| <b>Sicherheit</b>                    |
| <b>Safety</b>                        |
| Materialnr./Part No.<br>720108000001 |



Es gelten die Vorschriften und Sicherheitshinweise gemäß dem Service Manual "Sicherheit", Materialnummer 720108000001, sowie zusätzlich die eventuell abweichenden, landesspezifischen Vorschriften!



The regulations and safety instructions shall be valid as provided by the "Safety" Service Manual, part number 720108000001, as well as the respective national deviations.

# ALIGNMENT INSTRUCTIONS

## (1) ALIGNMENT FOR AM IF

- a. Required Instruments  
AM IF Sweep Generator with Scope
- b. Alignment Procedure

| Mode | Adjustment | Procedure   |
|------|------------|---|
| AM   | T2         | (1) Turn on the radio.<br>(2) Connect the input of the AM IF sweep generation in series with a resistor of 1.2K Ohm to the test point TP2 and TP7.<br>(3) Connect the RF output of the AM IF sweep generation in series with a resistor of 2.2K ohm to another test point TP3.<br>(4) Adjust T2 to have a max. output and best center marker frequency to 450kHz. |

### c. Instrument Connection

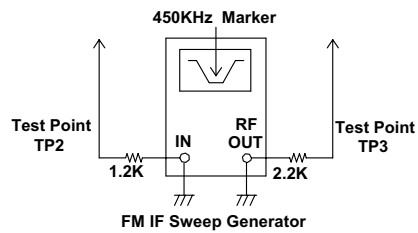
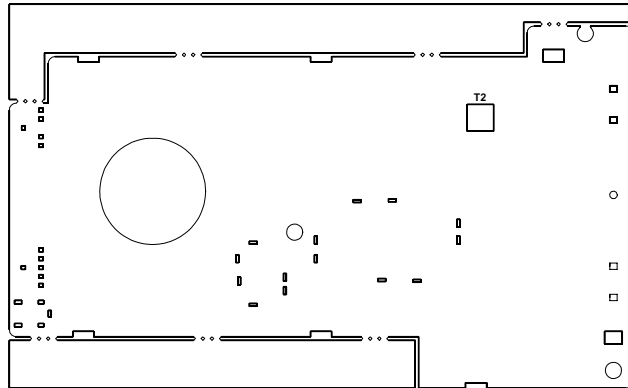

## (2) ALIGNMENT FOR FM IF

- a. Required Instruments  
FM IF Sweep Generator with Scope
- b. Alignment Procedure

| Mode | Adjustment | Procedure   |
|------|------------|---|
| FM   | T1         | (1) Turn on the radio.<br>(2) Connect the input of the FM IF sweep generation in series with a resistor of 1.2k Ohm to the test point TP4 and TP7.<br>(3) Connect the RF output of the FM IF sweep generation in series with a resistor of 2.2k ohm to another test point TP5.<br>(4) Adjust T1 have a max. output and best symmetrical S curve with respect to the Center marker frequency of 10.7MHz. |

### c. Instrument Connection

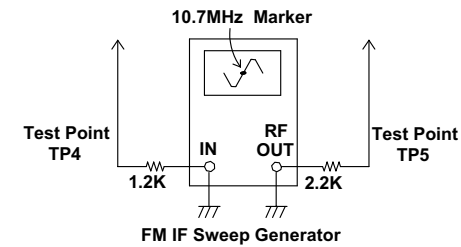
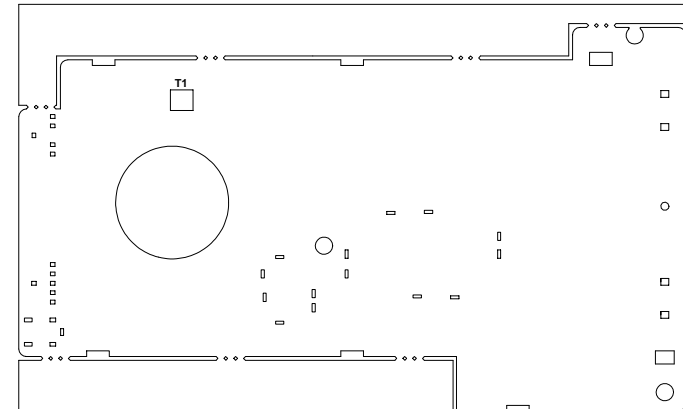

### (3) ALIGNMENT FOR FM VOLTAGE TUNING RANGE

a. Required Instruments  
DVM

b. Alignment Procedure

| Mode | Adjustment | Procedure  |
|------|------------|--|
|      | <b>L2</b>  | (1) Set the power switch to ON.<br>(2) Set "108 MHz".<br>(3) Connect at to the test point TP6 and TP7.<br>(4) Adjust L2 for show on 8.5V.<br>(5) Set "87.5MHz" and check on DVM between 2.2V – 2.7V. |

c. Instrument Connection

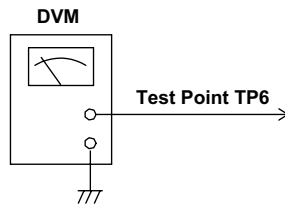
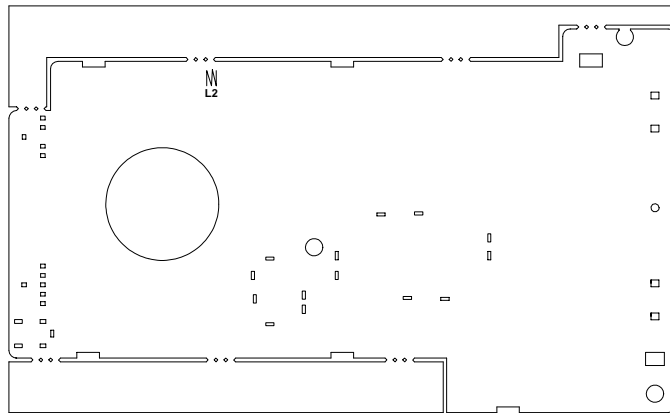

### (4) ALIGNMENT FOR AM VOLTAGE TUNING RANGE

a. Required Instruments  
DVM

b. Alignment Procedure

| Mode | Adjustment         | Procedure  |
|------|--------------------|--|
|      | <b>T10<br/>VC4</b> | (1) Set the power switch to ON.<br>(2) Set "520 kHz".<br>(3) Connect at to the test point TP6 and TP7.<br>(4) Adjust T10 for show on 1.10V.<br>(5) Set "1710 kHz" and adjust VC4 for DVM show on 8.5V. |

c. Instrument Connection

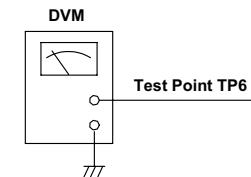
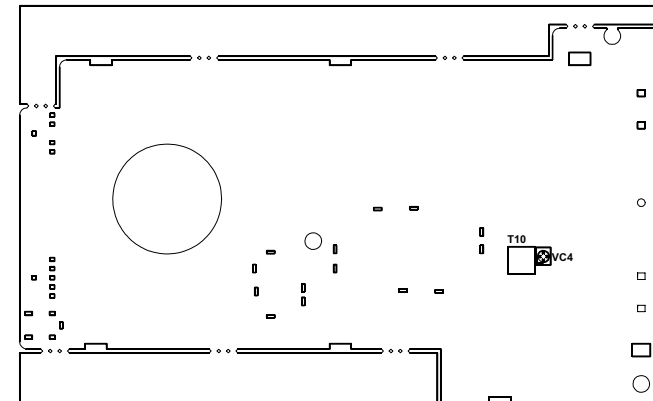

**(5) ALIGNMENT FOR LW VOLTAGE TUNING RANGE**

a. Required Instruments  
DVM

b. Alignment Procedure

| Mode | Adjustment         | Procedure  |
|------|--------------------|--|
|      | <b>T11<br/>VC5</b> | (1) Set the power switch to ON.<br>(2) Set " 153 kHz".<br>(3) Connect at to the test point TP6 and TP7.<br>(4) Adjust T11 for show on 1.20V.<br>(5) Set "279 kHz" and adjust VC5 for DVM show on 5.00. |

c. Instrument Connection

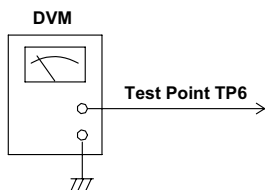
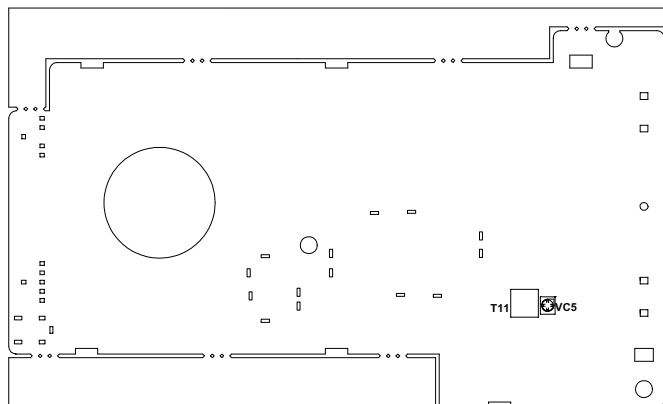

**(6) ALIGNMENT FOR FM SENSITIVITY**

a. Required Instruments  
FM Signal Generator  
SSVM

b. Alignment Procedure

| Mode | Adjustment        | Procedure   |
|------|-------------------|---|
|      | <b>L1<br/>VC1</b> | (1) Set the power switch to ON.<br>(2) Connect a SSVM to the test point TP8 and TP9.<br>(3) Connect the output of the FM signal generator to the test point TP5 and TP7.<br>(4) Set FM 90 MHz.<br>(5) Adjust L1 to have a max. Audio output.<br>(6) Set FM 106 MHz.<br>(7) Adjust VC1 to have a max. Audio output.<br>(8) Repeat steps 4-7 until best sensitivity on these two frequency is formed. |

c. Instrument Connection

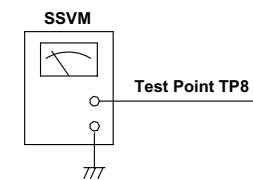
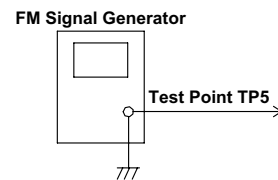
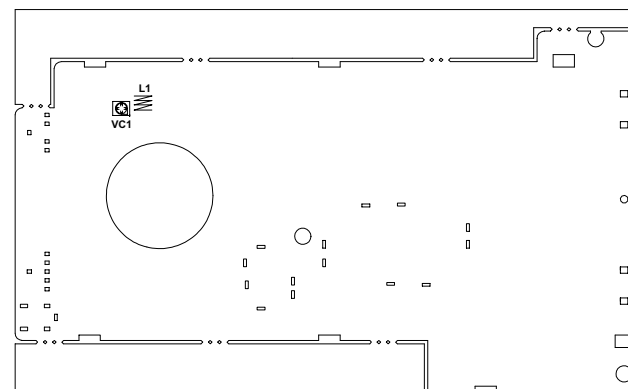

**(7) ALIGNMENT FOR AM SENSITIVITY**

a. Required Instruments  
 AM Signal Generator  
 SSVM

b. Alignment Procedure

| Mode | Adjustment          | Procedure   |
|------|---------------------|---|
|      | <b>L19A<br/>VC2</b> | (1) Set the power switch to ON.<br>(2) Connect a SSVM to the test point TP8 and TP9.<br>(3) Connect the output of the FM signal generator to the test point TP8 and TP9.<br>(4) Set AM 600 kHz.<br>(5) Adjust L19A to have a max. Audio output.<br>(6) Set AM 1400 kHz.<br>(7) Adjust VC2 to have a max. Audio output.<br>(8) Repeat steps 4-7 until best sensitivity on these two frequency is formed. |

c. Instrument Connection

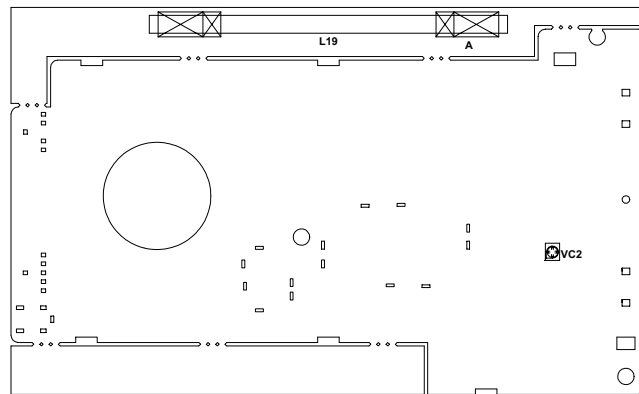

AM Signal Generator

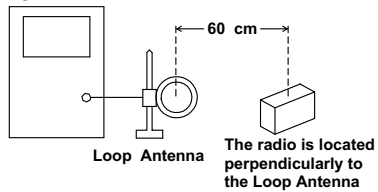

SSVM

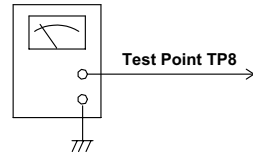

**(8) ALIGNMENT FOR LW SENSITIVITY**

a. Required Instruments  
 AM Signal Generator  
 SSVM

b. Alignment Procedure

| Mode | Adjustment          | Procedure   |
|------|---------------------|---|
|      | <b>L19B<br/>VC3</b> | (1) Set the power switch to ON.<br>(2) Connect a SSVM to the test point TP8 and TP9.<br>(3) Connect the output of the AM signal generator to a standard loop antenna.<br>(4) Set LW 162 kHz.<br>(5) Adjust L19B to have a max. Audio output.<br>(6) Set LW 270 kHz.<br>(7) Adjust VC3 to have a max. Audio output.<br>(8) Repeat steps 4-7 until best sensitivity on these two frequencies is formed. |

c. Instrument Connection

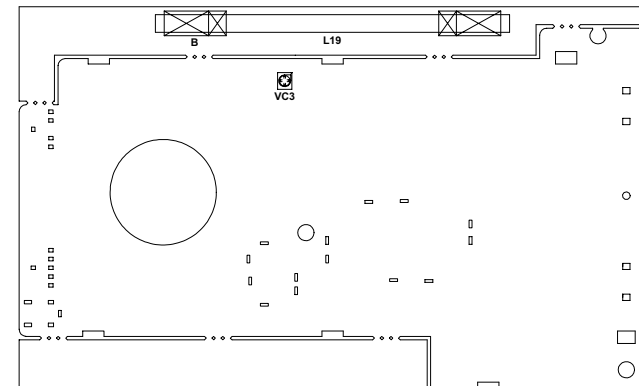

AM Signal Generator

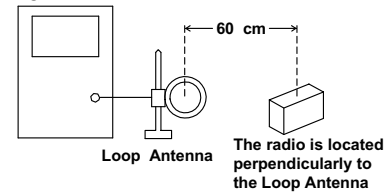

SSVM

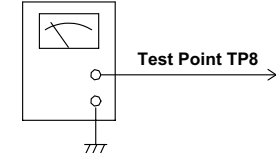

**(9) ALIGNMENT FOR SW 2 ND LOCAL OSC**

- a. Required Instruments  
Frequency counter with higher impedunce probe
- b. Alignment Procedure

| Mode | Adjustment | Procedure   |
|------|------------|---|
| AM   | T8         | (1) Turn the radio ON.<br>(2) Turn the frequency for away from any station to avoid interference.<br>(3) Connect the test probes of frequency counter to TP10 and TP7.<br>(4) Adjust T8 to have a reading of 20.9898 – 20.9902 MHz. |

Coution : a loading effect could emerge in the circuit if inserted with a lower impedunce probe of frequency Counter.

c. Instrument Connection

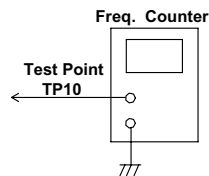
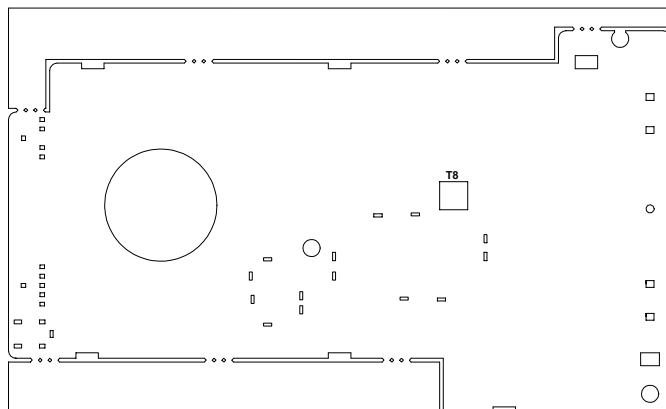

**(10) ALIGNMENT FOR SW SENSITIVITY**

- a. Required Instruments  
AM Signal Generator  
SSVM
- b. Alignment Procedure

| Mode | Adjustment     | Procedure   |
|------|----------------|---|
|      | T6<br>T7<br>T9 | (1) Turn on the radio.<br>(2) Tune the radio band frequency to 15.100 MHz.<br>(3) Feed a signal with modulation from the AM signal generator output to tese point TP5 and connect a SSVM to the speaker (TP8).<br>(4) Tune the generator frequency to exactly the same as that of the radio frequency Displayed.<br>(5) Adjust T6, T7 and T9.<br>(6) Remove steps (5) until test sensitivity. |

c. Instrument Connection

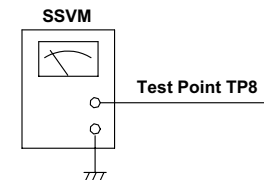
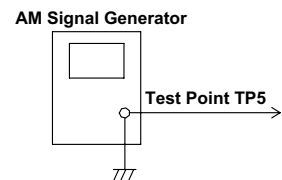
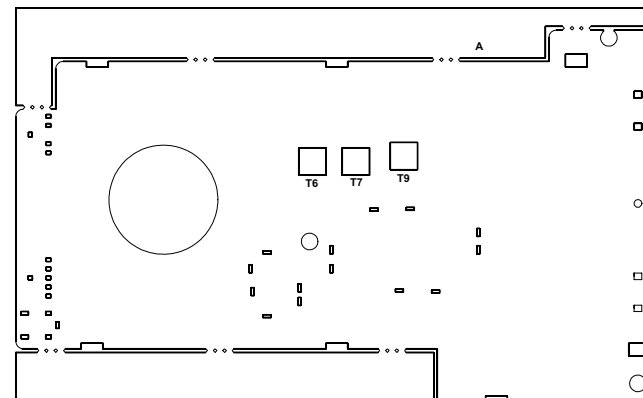

**(11) ALIGNMENT FOR SW SENSITIVITY**

a. Required Instruments  
 AM Signal Generator  
 SSVM

b. Alignment Procedure

| Mode | Adjustment | Procedure   |
|------|------------|---|
|      | VC6        | (1) Set the power switch to the ON position.<br>(2) Set the band to SW. SSB switch to ON, and clarify.ur to center position.<br>(3) Feed a signal without modulation from the signal generator to the EXT ANT jack, And connect a SSVM to the test point TP8.<br>(4) Tune the radio frequency to exactly the same as that of the signal generator.<br>(5) Adjust VC6 to have a minimum reading on the SSVM. |

c. Instrument Connection

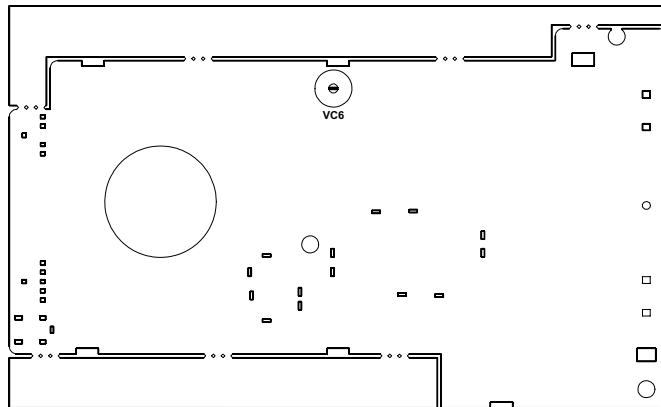

AM Signal Generator

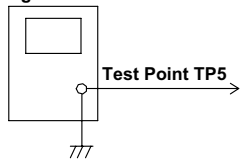

SSVM

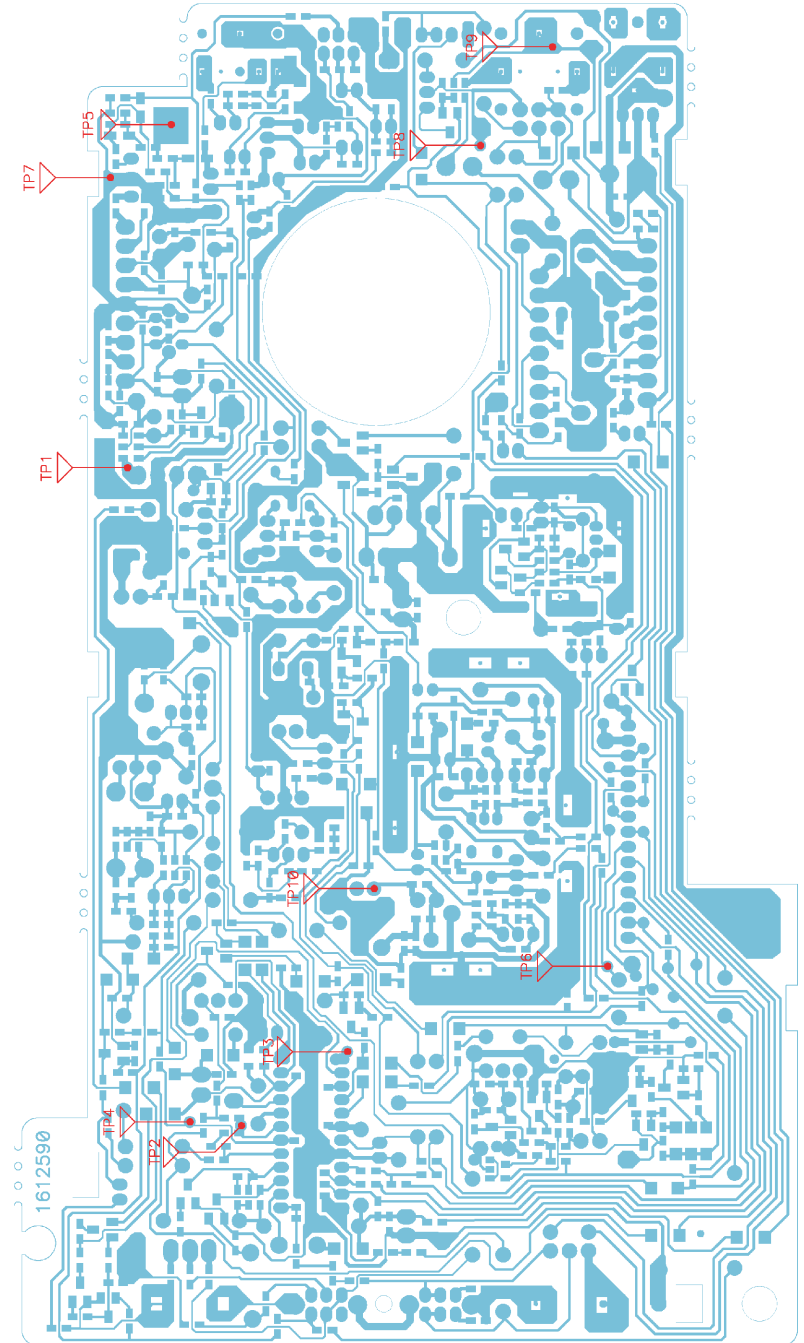
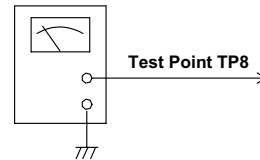

1612500

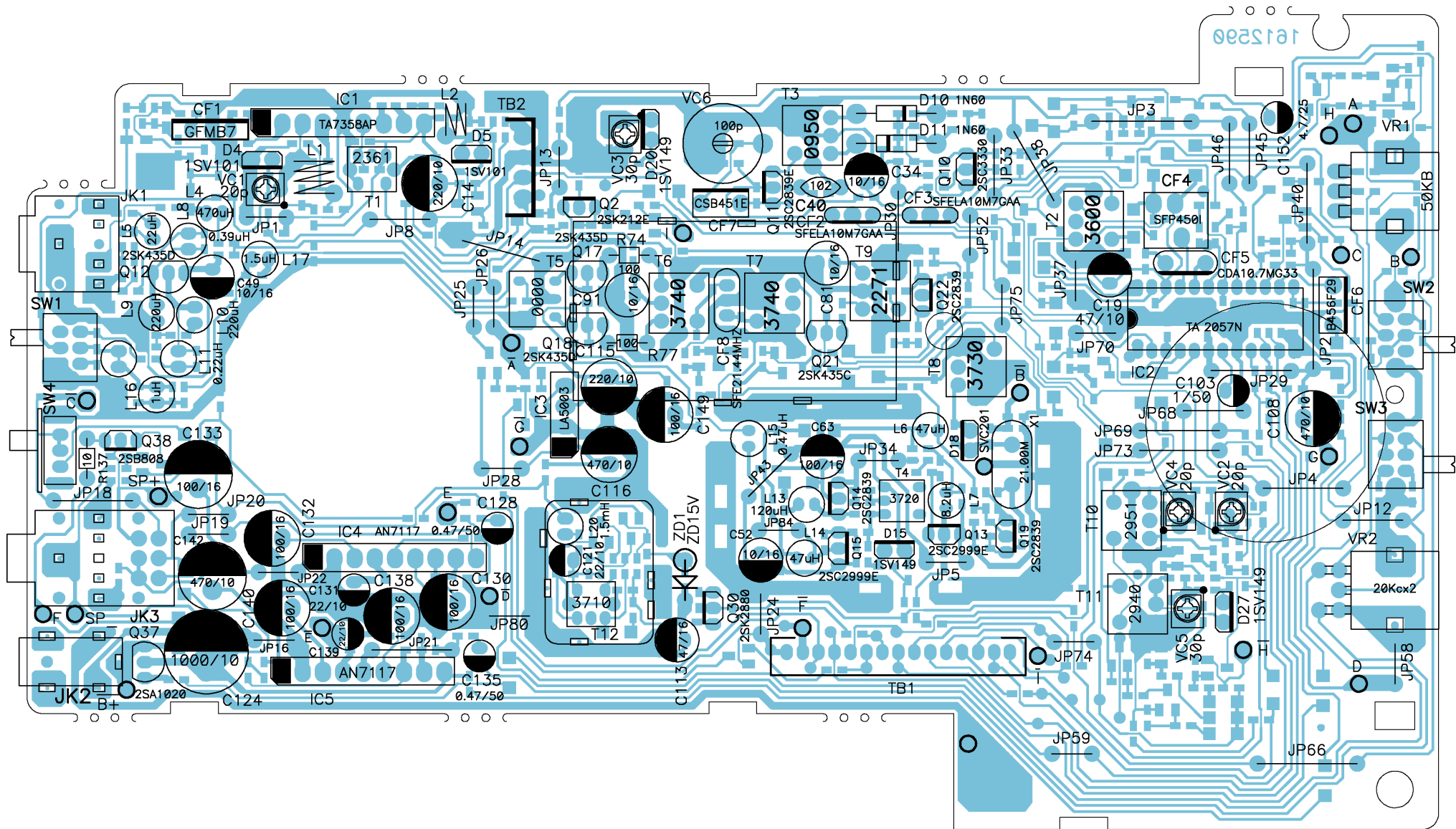



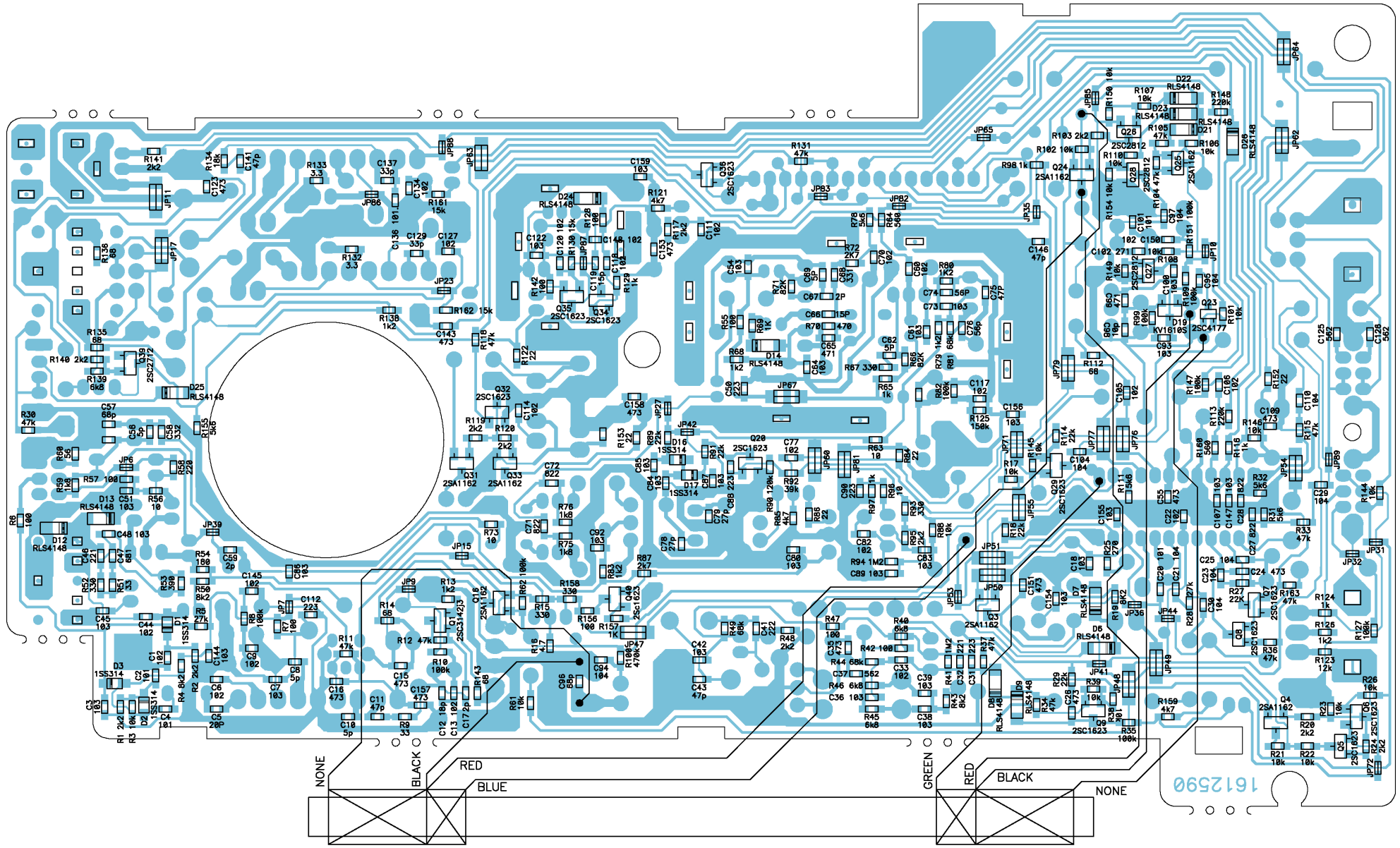

L19B LW

L19A MW

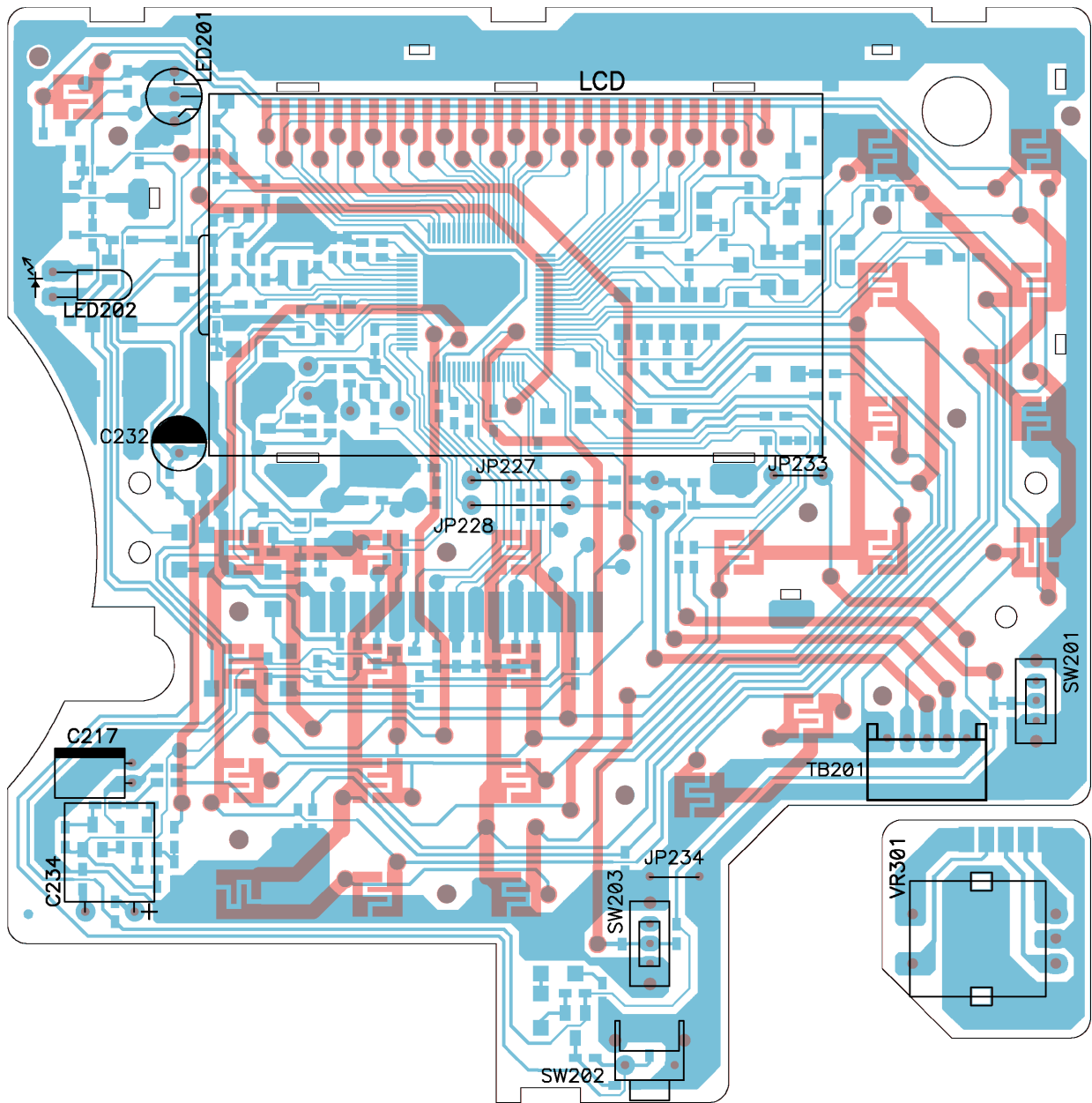

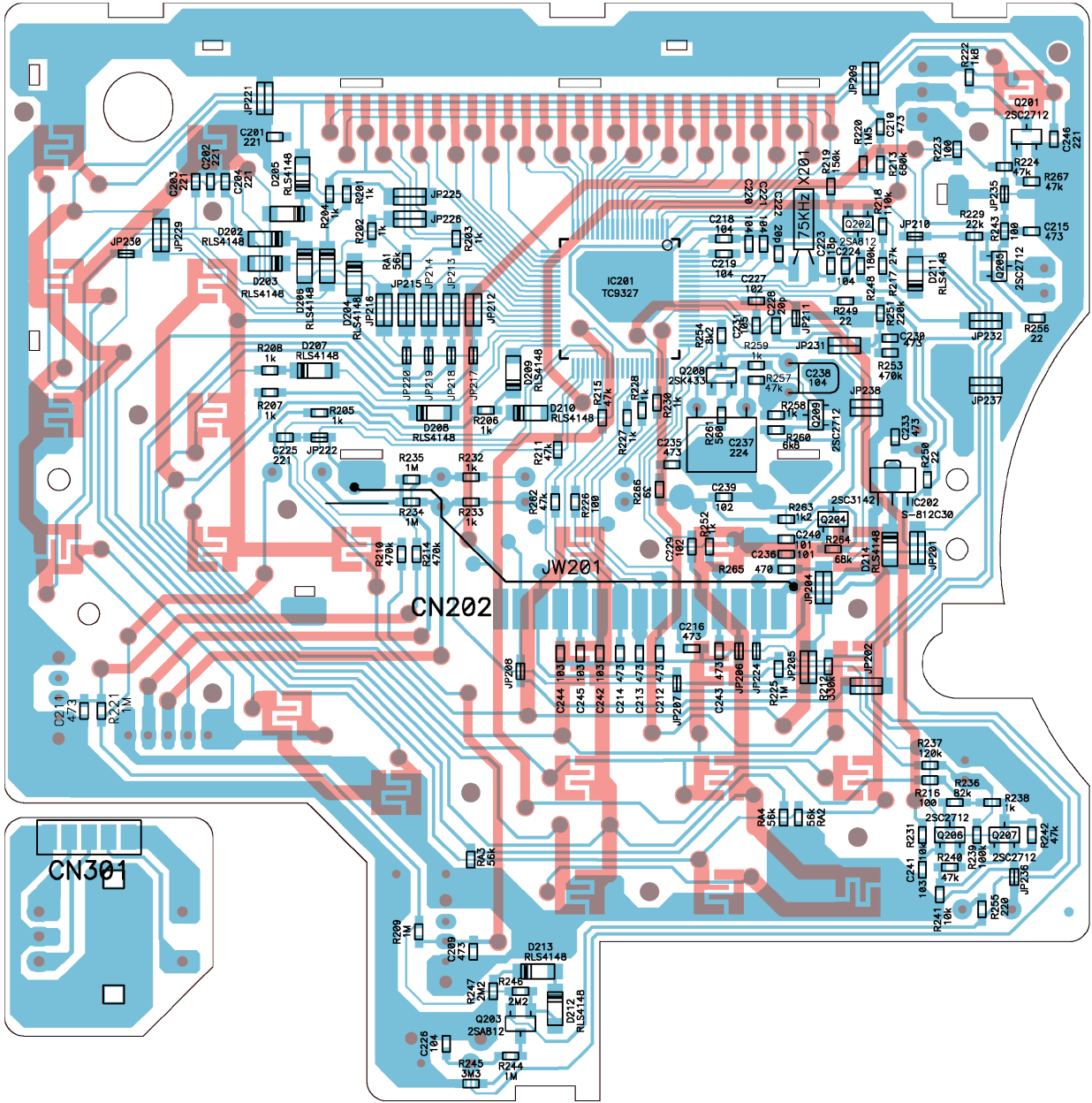

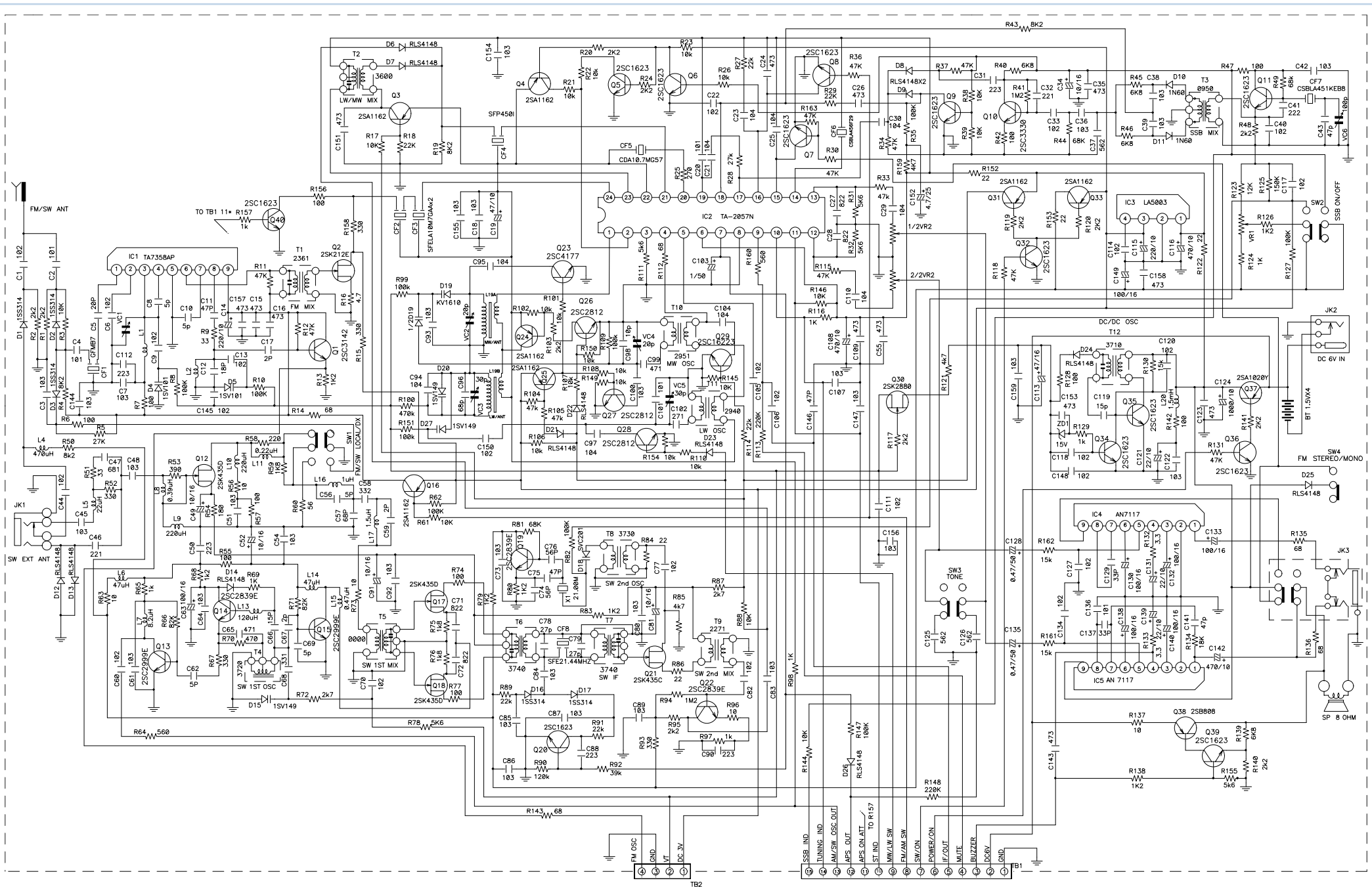

{Note 1}

|         |         |    |
|---------|---------|----|
|         | YES     | NO |
| D201    | ITALIAN | CE |
| RLS4148 |         |    |

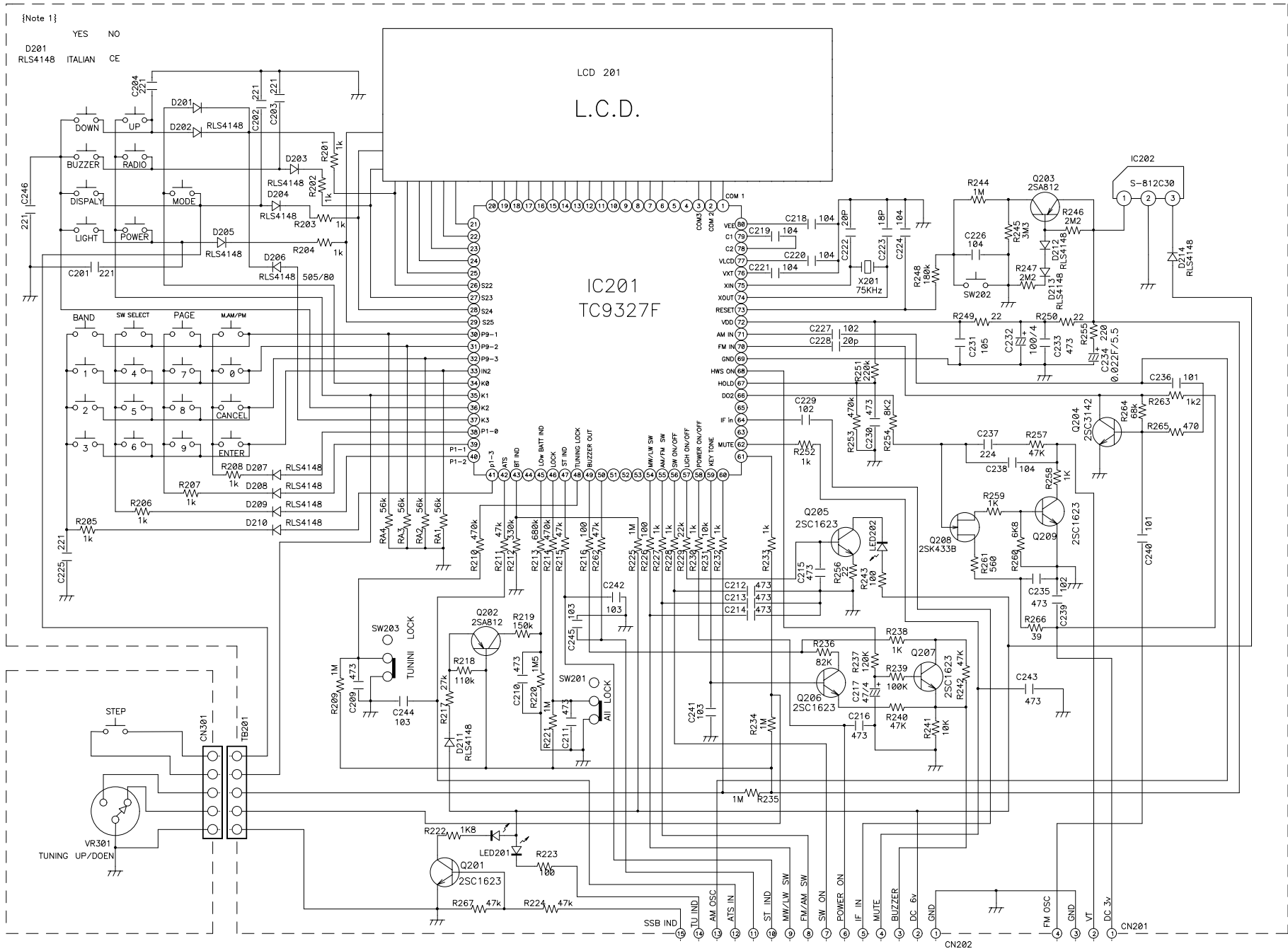

## TROUBLESHOOTING FLOW CHART

### ( 1 ) Weak sensitivity in FM mode

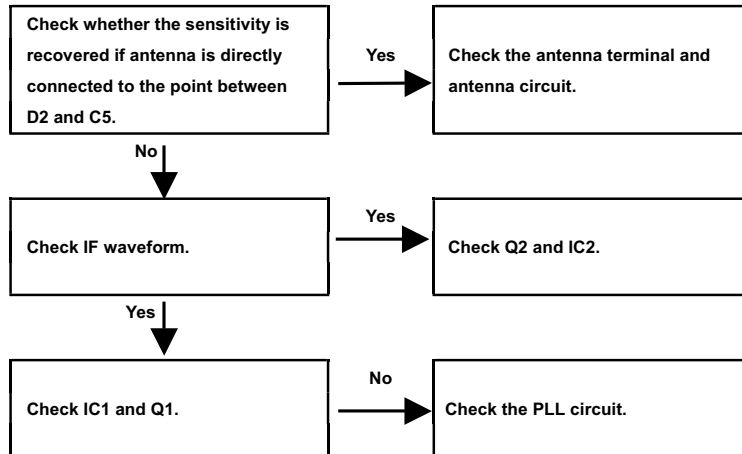

### ( 2 ) Weak sensitivity on SM band

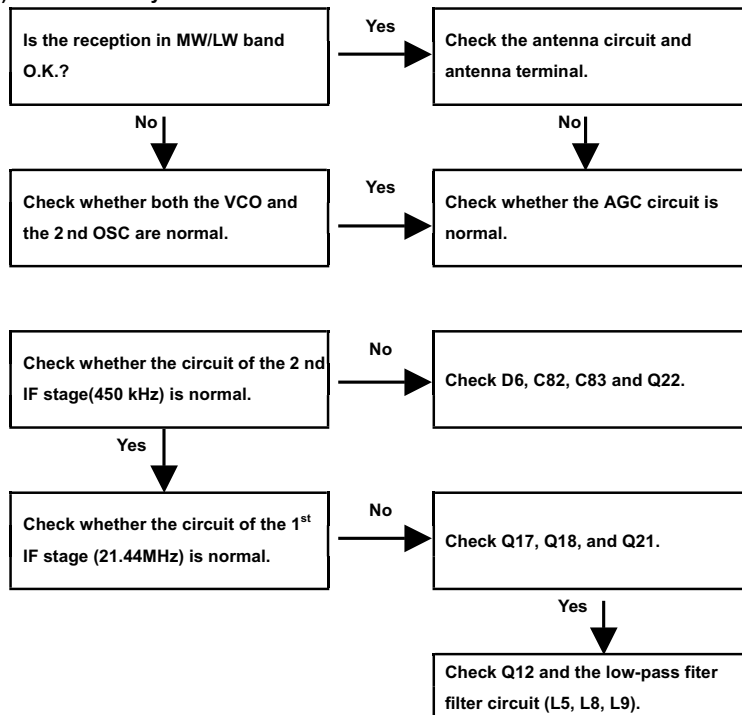

### ( 3 ) PLL does not work

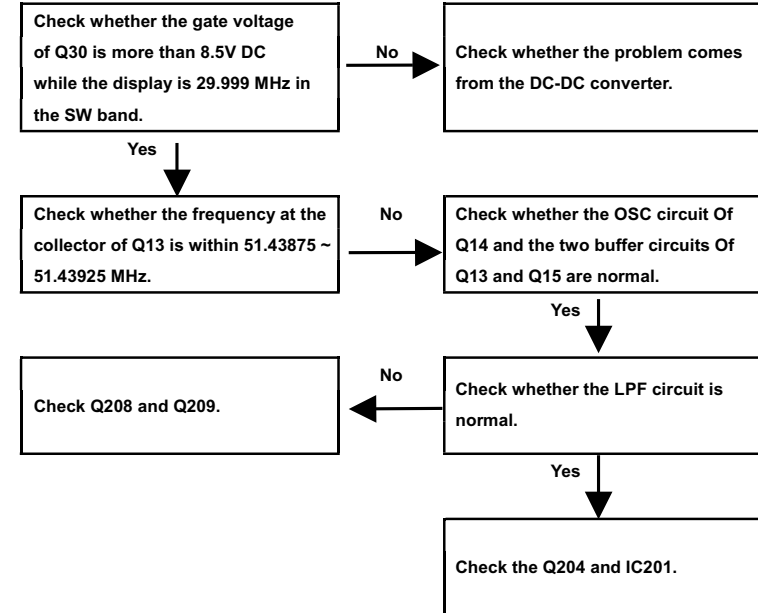



( 4 ) Power cannot be turned on

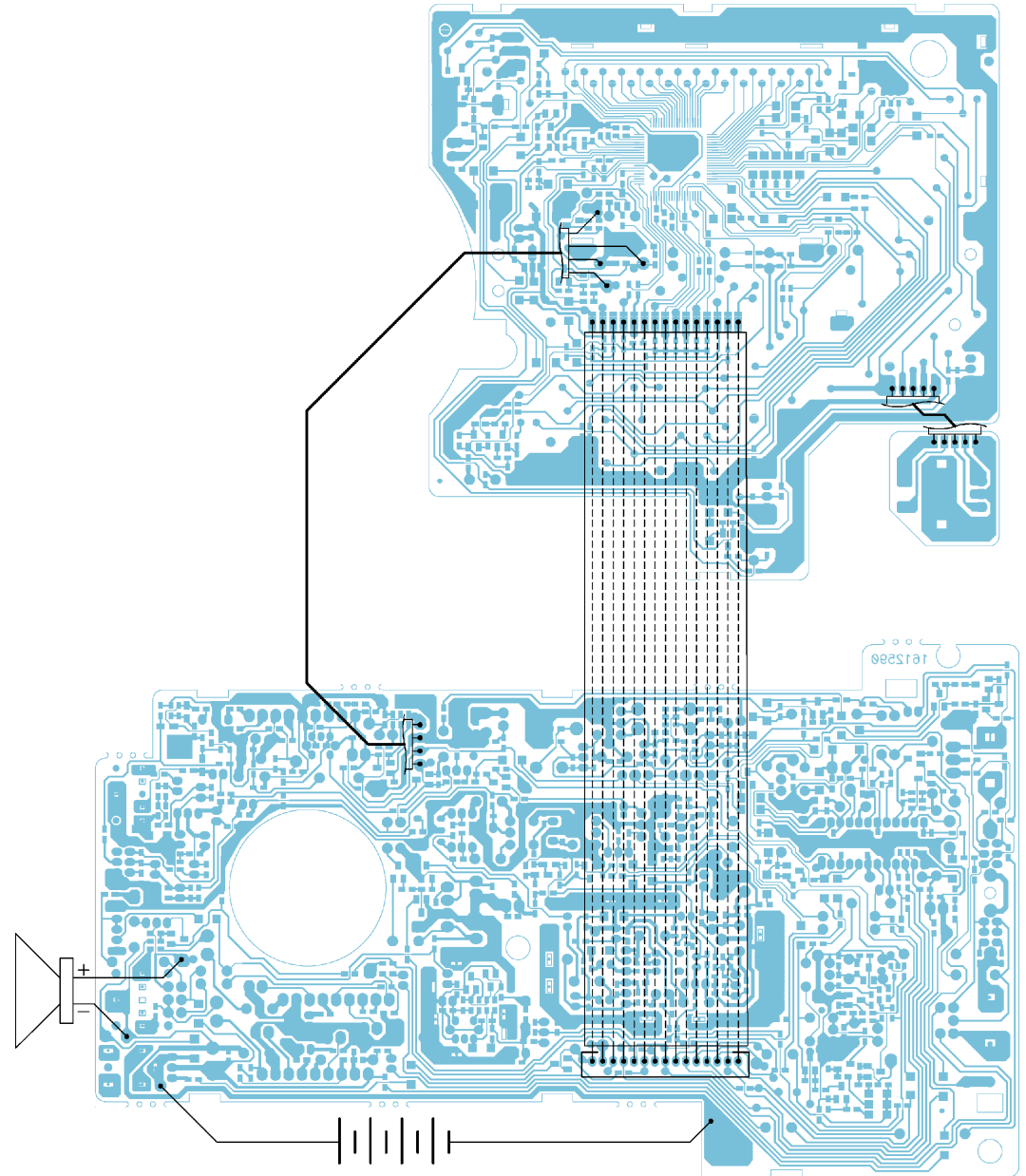
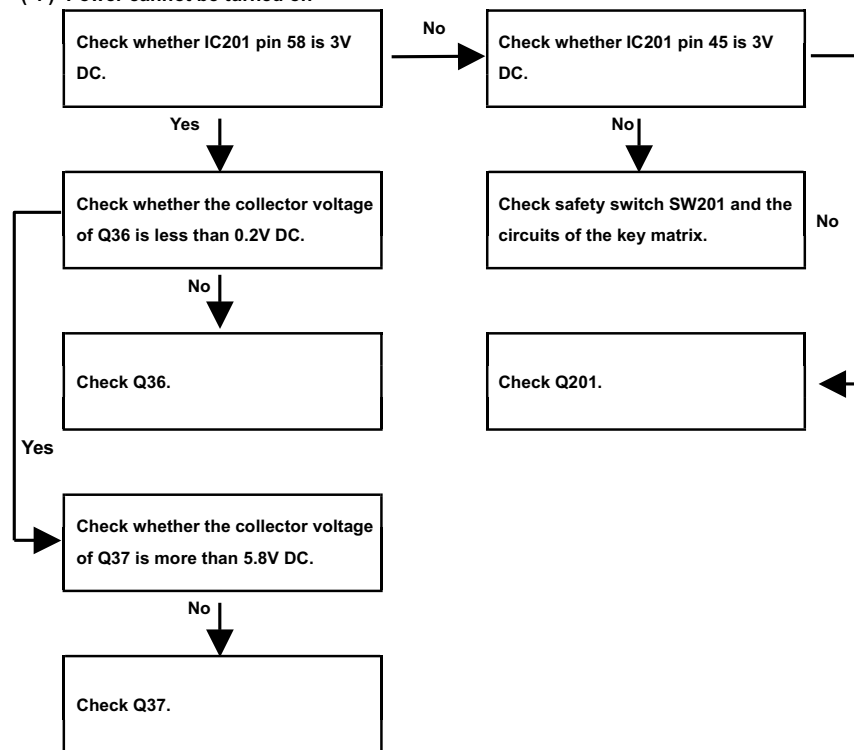

# IC CIRCUIT BLOCK DIAGRAM

1. IC1-TA7358AP

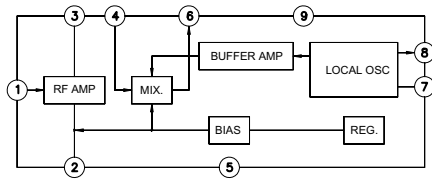

2. IC3-TA2057N

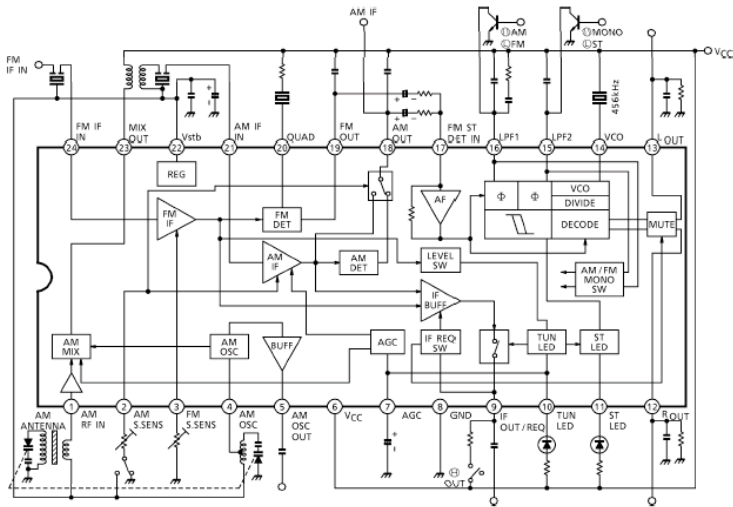

3. IC3-LA5003

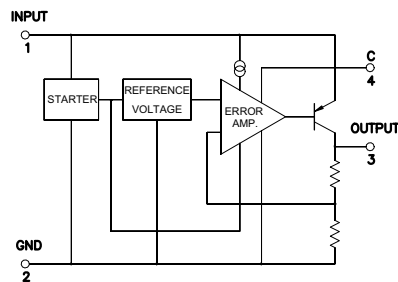

4. IC201-TC9327AF

BLOCK DIAGRAM

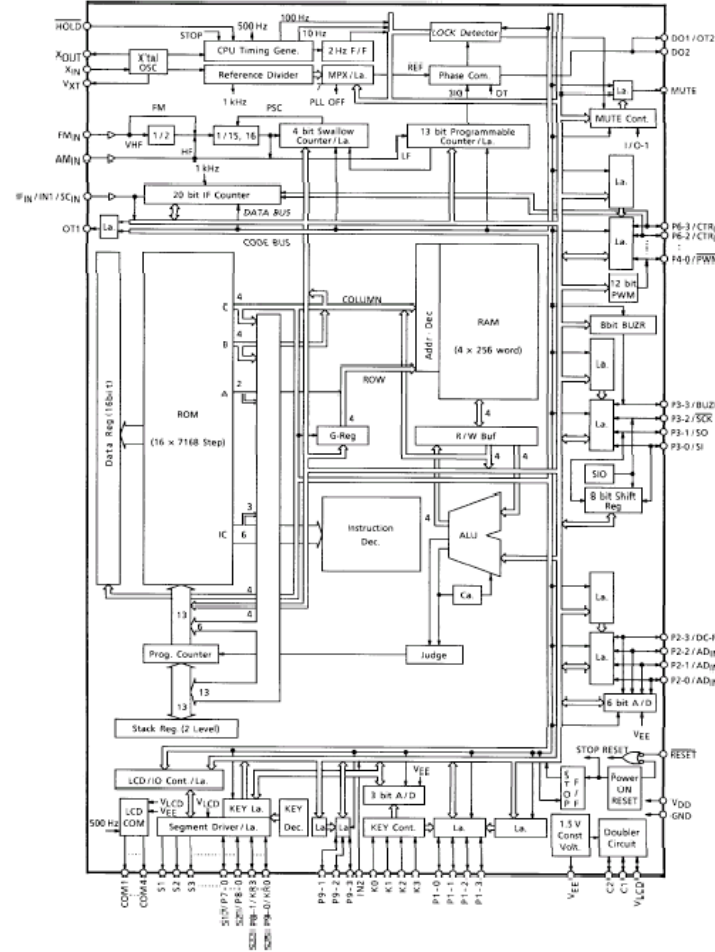

5. IC4e 5-AN7117

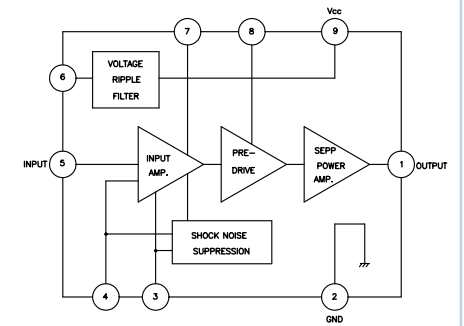

6. IC202-S-812C30

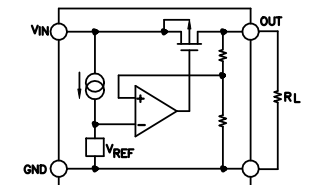



# IC AND TRANSISTOR VOLTAGE CHART

IC1-TA7358AP

| PIN | FM   | AM  |
|-----|------|-----|
| 1   | 0.85 | --- |
| 2   | 1.55 | --- |
| 3   | 2.67 | --- |
| 4   | 1.52 | --- |
| 5   | 0    | --- |
| 6   | 2.68 | --- |
| 7   | 1.96 | --- |
| 8   | 2.62 | --- |
| 9   | 2.67 | --- |

| PIN | FM    | AM    |
|-----|-------|-------|
| 1   | 7.75  | 7.80  |
| 2   | 15.35 | 15.34 |
| 3   | 8.03  | 8.03  |
| 4   | 8.03  | 8.03  |
| 5   | 0.10  | 0.10  |
| 6   | 5.32  | 5.32  |
| 7   | 0.93  | 0.94  |
| 8   | 5.32  | 5.33  |
| 9   | 5.30  | 5.32  |
| 10  | 0     | 0     |

IC2-TA2057N

| PIN | FM   | AM   |
|-----|------|------|
| 1   | 1.89 | 1.93 |
| 2   | 0.93 | 0.95 |
| 3   | 0    | 0    |
| 4   | 1.89 | 1.92 |
| 5   | 5.24 | 5.04 |
| 6   | 5.25 | 5.34 |
| 7   | 0    | 0    |
| 8   | 0    | 0    |
| 9   | 0    | 0    |
| 10  | 4.38 | 4.39 |
| 11  | 4.85 | 4.96 |
| 12  | 1.52 | 1.52 |
| 13  | 1.47 | 1.47 |
| 14  | 4.66 | 4.75 |
| 15  | 0    | 0    |
| 16  | 3.47 | 0    |
| 17  | 1.37 | 1.39 |
| 18  | 0.18 | 1.39 |
| 19  | 1.19 | 1.31 |
| 20  | 1.05 | 1.38 |
| 21  | 1.89 | 1.93 |
| 22  | 1.89 | 1.93 |
| 23  | 5.25 | 5.35 |
| 24  | 1.89 | 0.40 |

IC3-LA5003

| PIN | FM   | AM   |
|-----|------|------|
| 1   | 5.33 | 5.43 |
| 2   | 0    | 0    |
| 3   | 3.01 | 3.01 |
| 4   | 4.70 | 4.87 |

IC4,5-AN7117

| PIN | FM   | AM   |
|-----|------|------|
| 1   | 2.75 | 2.74 |
| 2   | 0    | 0    |
| 3   | 2.73 | 2.73 |
| 4   | 2.74 | 2.73 |
| 5   | 2.64 | 2.64 |
| 6   | 5.89 | 5.89 |
| 7   | 0    | 0    |
| 8   | 3.31 | 3.31 |
| 9   | 5.94 | 5.94 |

IC202-S-812C30

| PIN | FM   | AM   |
|-----|------|------|
| 1   | 5.30 | 5.30 |
| 2   | 0    | 0    |
| 3   | 2.97 | 2.97 |

IC201-TC9327F

| PIN | FM   | AM   |
|-----|------|------|
| 1   | 1.50 | 1.50 |
| 2   | 1.50 | 1.50 |
| 3   | 1.50 | 1.50 |
| 4   | 1.50 | 1.50 |
| 5   | 1.50 | 1.50 |
| 6   | 1.50 | 1.50 |
| 7   | 1.50 | 1.50 |
| 8   | 1.50 | 1.50 |
| 9   | 1.50 | 1.50 |
| 10  | 1.50 | 1.50 |
| 11  | 1.50 | 1.50 |
| 12  | 1.50 | 1.50 |
| 13  | 1.50 | 1.50 |
| 14  | 1.50 | 1.50 |
| 15  | 1.50 | 1.50 |
| 16  | 1.50 | 1.50 |
| 17  | 1.50 | 1.50 |
| 18  | 1.50 | 1.50 |
| 19  | 1.50 | 1.50 |
| 20  | 1.50 | 1.50 |
| 21  | 1.50 | 1.50 |
| 22  | 1.50 | 1.50 |
| 23  | 1.50 | 1.50 |
| 24  | 1.50 | 1.50 |
| 25  | 1.50 | 1.50 |
| 26  | 1.50 | 1.50 |
| 27  | 1.50 | 1.50 |
| 28  | 1.50 | 1.50 |
| 29  | 1.50 | 1.50 |
| 30  | 0    | 0    |

| PIN | FM   | AM   |
|-----|------|------|
| 31  | 0    | 0    |
| 32  | 0    | 0    |
| 33  | 0    | 0    |
| 34  | 0.22 | 0.22 |
| 35  | 0.25 | 0.25 |
| 36  | 0.23 | 0.23 |
| 37  | 0.25 | 0.25 |
| 38  | 0    | 0    |
| 39  | 0    | 0    |
| 40  | 0    | 0    |
| 41  | 0    | 0    |
| 42  | 0    | 0    |
| 43  | 0    | 0    |
| 44  | ---  | ---  |
| 45  | 0    | 0    |
| 46  | 0    | 0    |
| 47  | 3.29 | 3.29 |
| 48  | ---  | ---  |
| 49  | 0    | 0    |
| 50  | ---  | ---  |
| 51  | ---  | ---  |
| 52  | ---  | ---  |
| 53  | ---  | ---  |
| 54  | 0.57 | 0.57 |
| 55  | 0    | 0    |
| 56  | 0    | 0    |
| 57  | 0    | 0    |
| 58  | 2.70 | 2.90 |
| 59  | 0    | 0    |
| 60  | 1.50 | 1.50 |

| PIN | FM   | AM   |
|-----|------|------|
| 61  | 1.50 | 1.50 |
| 62  | 0    | 0    |
| 63  | ---  | ---  |
| 64  | 1.16 | 1.20 |
| 65  | ---  | ---  |
| 66  | 0.19 | 0.18 |
| 67  | 1.76 | 1.81 |
| 68  | 0    | 0    |
| 69  | 0    | 0    |
| 70  | 1.27 | 0    |
| 71  | 0    | 0.72 |
| 72  | 2.80 | 2.80 |
| 73  | 1.55 | 1.55 |
| 74  | 0.32 | 0.32 |
| 75  | 0    | 0    |
| 76  | 1.41 | 1.41 |
| 77  | 2.94 | 2.93 |
| 78  | 0.74 | 0.73 |
| 79  | 2.21 | 2.20 |
| 80  | 1.49 | 1.48 |

Transistor

|     |   | FM   | AM   |
|-----|---|------|------|
| Q1  | C | 2.68 | ---  |
|     | B | 1.99 | ---  |
|     | E | 1.31 | ---  |
| Q2  | D | 2.35 | 2.35 |
|     | S | 0.01 | 0.01 |
|     | G | 0    | 0    |
| Q3  | C | 1.89 | 0    |
|     | B | 1.16 | 5.92 |
|     | E | 1.90 | 1.98 |
| Q4  | C | 1.88 | 1.97 |
|     | B | 1.28 | 1.36 |
|     | E | 1.90 | 1.98 |
| Q5  | C | 0    | 1.44 |
|     | B | 0.64 | 0    |
|     | E | 0    | 0    |
| Q6  | C | 1.15 | 0    |
|     | B | 0    | 0.65 |
|     | E | 0    | 0    |
| Q7  | C | 0    | 0    |
|     | B | 0.76 | 0.76 |
|     | E | 0    | 0    |
| Q8  | C | 3.47 | 0    |
|     | B | 0    | 0.61 |
|     | E | 0    | 0    |
| Q9  | C | 1.90 | 0    |
|     | B | 0    | 0.65 |
|     | E | 0    | 0    |
| Q10 | C | ---  | 1.07 |
|     | B | ---  | 0.56 |
|     | E | ---  | 0    |
| Q11 | C | ---  | 1.81 |
|     | B | ---  | 0.39 |
|     | E | ---  | 0    |
| Q12 | D | ---  | 5.4  |
|     | S | ---  | 0.69 |
|     | G | ---  | 0.02 |

|     |   | FM   | AM   |
|-----|---|------|------|
| Q13 | C | ---  | 2.07 |
|     | B | ---  | 0.71 |
|     | E | ---  | 0    |
| Q14 | C | ---  | 1.85 |
|     | B | ---  | 1.55 |
|     | E | ---  | 0    |
| Q15 | C | ---  | 1.09 |
|     | B | ---  | 0.70 |
|     | E | ---  | 0    |
| Q16 | C | 2.73 | 0    |
|     | B | 2.21 | 2.93 |
|     | E | 2.89 | 2.97 |
| Q17 | D | ---  | 5.08 |
|     | S | ---  | 1.14 |
|     | G | ---  | 0    |
| Q18 | D | ---  | 5.08 |
|     | S | ---  | 1.14 |
|     | G | ---  | 0    |
| Q19 | C | ---  | 1.30 |
|     | B | ---  | 1.12 |
|     | E | ---  | 0.53 |
| Q20 | C | ---  | 1.69 |
|     | B | ---  | 0    |
|     | E | ---  | 0    |
| Q21 | D | ---  | 5.50 |
|     | S | ---  | 1.04 |
|     | G | ---  | 0    |
| Q22 | C | ---  | 2.41 |
|     | B | ---  | 0.75 |
|     | E | ---  | 0.19 |
| Q23 | C | 0    | 0    |
|     | B | 0.63 | 0    |
|     | E | 0    | 0    |
| Q24 | C | 1.90 | 1.98 |
|     | B | 1.88 | 1.96 |
|     | E | 1.90 | 1.98 |

|     |   | FM   | AM   |
|-----|---|------|------|
| Q25 | C | 2.80 | 0    |
|     | B | 2.28 | 2.91 |
|     | E | 2.89 | 2.97 |
| Q26 | C | 1.87 | 0    |
|     | B | 0.16 | 0.62 |
|     | E | 0    | 0    |
| Q27 | C | 0    | 0    |
|     | B | 0.63 | 0    |
|     | E | 9    | 0    |
| Q28 | C | 0    | 0    |
|     | B | 0.17 | 0.61 |
|     | E | 0    | 0    |
| Q29 | C | 0    | 0    |
|     | B | 0.35 | 0.63 |
|     | E | 0    | 0    |
| Q30 | D | 2.36 | 2.54 |
|     | S | 8.79 | 8.79 |
|     | G | 2.56 | 2.73 |
| Q31 | C | 1.15 | 5.92 |
|     | B | 5.33 | 5.21 |
|     | E | 5.95 | 5.94 |
| Q32 | C | 0    | 5.32 |
|     | B | 0.66 | 0    |
|     | E | 0    | 0    |
| Q33 | C | 0    | 2.86 |
|     | B | 5.30 | 2.19 |
|     | E | 2.89 | 2.89 |
| Q34 | C | 5.9  | 5.9  |
|     | B | 0.8  | 0.8  |
|     | E | 0    | 0    |
| Q35 | C | 5.95 | 5.95 |
|     | B | 5.90 | 5.90 |
|     | E | 0    | 0    |
| Q36 | C | 0.10 | 0.10 |
|     | B | 0.64 | 0.64 |
|     | E | 0    | 0    |

## SEMICONDUCTOR LEAD IDENTIFICATION

|     |   | FM   | AM   |
|-----|---|------|------|
| Q37 | C | 5.95 | 5.95 |
|     | B | 5.31 | 5.31 |
|     | E | 5.99 | 5.99 |
| Q38 | C | 0    | 0    |
|     | B | 5.52 | 5.85 |
|     | E | 5.99 | 5.99 |
| Q39 | C | 5.83 | 5.52 |
|     | B | 0    | 0    |
|     | E | 0.16 | 0.04 |
| Q40 | C | 2.35 | 2.35 |
|     | B | 0    | 0    |
|     | E | 0    | 0    |

|      |   | FM   | AM   |
|------|---|------|------|
| Q201 | C | 4.60 | 4.60 |
|      | B | 0    | 0    |
|      | E | 0    | 0    |
| Q202 | C | 3.85 | 3.85 |
|      | B | 2.97 | 2.97 |
|      | E | 3.85 | 3.85 |
| Q203 | C | 2.95 | 2.95 |
|      | B | 2.45 | 2.45 |
|      | E | 2.97 | 2.97 |
| Q204 | C | 1.19 | 1.14 |
|      | B | 0.73 | 0.74 |
|      | E | 0    | 0    |
| Q205 | C | 0    | 0    |
|      | B | 0    | 0    |
|      | E | 0    | 0    |
| Q206 | C | 0    | 0    |
|      | B | 0    | 0    |
|      | E | 0    | 0    |
| Q207 | C | 0    | 0    |
|      | B | 0    | 0    |
|      | E | 0    | 0    |
| Q208 | D | 2.81 | 2.81 |
|      | S | 0.75 | 0.75 |
|      | G | 0.18 | 0.18 |
| Q209 | C | 2.07 | 0.81 |
|      | B | 0    | 0.60 |
|      | E | 0    | 0    |

### Transistors

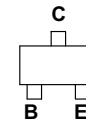

2SC2812L6



2SA1020Y

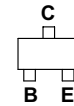

2SC4933F4  
2SC4177L7  
2SA1576A/R  
2SC4081R

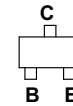

DA114

(E: Emitter C: Collector B: Base S: Source G: Gate D: Drain)

### Diodes

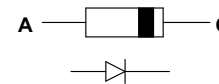

1N4002  
HBZX55C4V3



RL-S4148

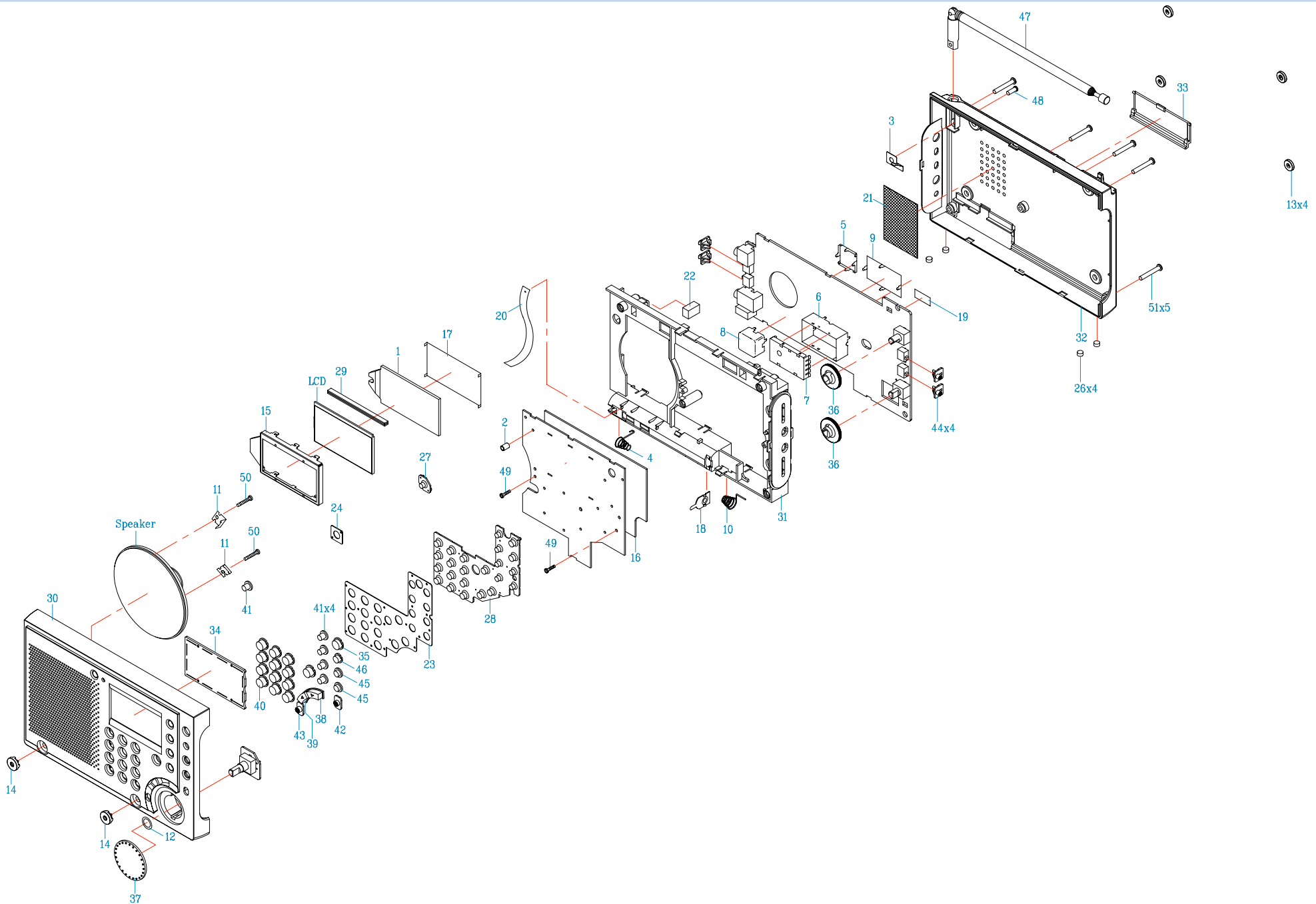

# GRUNDIG

Ersatzteilliste  
Spare Parts List

## AUDIO/HIFI

11 / 2003

### YACHT BOY 80 WR5408 PLL

MATERIAL-NR. / PART NO.: 759816000800  
BESTELL-NR. / ORDER NO.: GRO0450 CHROM/CHROME

| POS. NR.<br>POS. NO. | ABB.<br>FIG. | MATERIAL-NR.<br>PART NUMBER | ANZ.<br>QTY. | BEZEICHNUNG<br>①  | DESCRIPTION<br>②   |
|----------------------|--------------|-----------------------------|--------------|---|--|
|                      |              | 759816000800                |              | YACHT BOY 80 / WR 5408 PLL CHROM<br><b>TAUSCHGERAET</b> | YACHT BOY 80 / WR 5408 PLL CHROME<br><b>EXCHANGE SET</b> |
|                      |              | 759545015300                |              | DECKEL BATTERIE   | BATTERY COVER  |
|                      |              | 720114036000                |              | BEDIENUNGSANLEITUNG<br>D/GB/F/I/P/E/NL/PL/DK/S/FIN      | INSTRUCTION MANUAL<br>D/GB/F/I/P/E/NL/PL/DK/S/FIN        |

Es gelten die Vorschriften und Sicherheitshinweise gemäß dem Service Manual "Sicherheit", Mat.-Nummer 720108000001, sowie zusätzlich die eventuell abweichenden, landesspezifischen Vorschriften!



The regulations and safety instructions shall be valid as provided by the "Safety" Service Manual, part number 720108000001, as well as the respective national deviations.

ÄNDERUNGEN VORBEHALTEN / SUBJECT TO ALTERATION